





Model: DW503-SW

ASSEMBLY INSTRUCTIONS

- | | | |
|---|---|---|
|  |  |  |
|  |  |  |

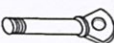

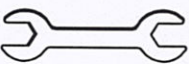
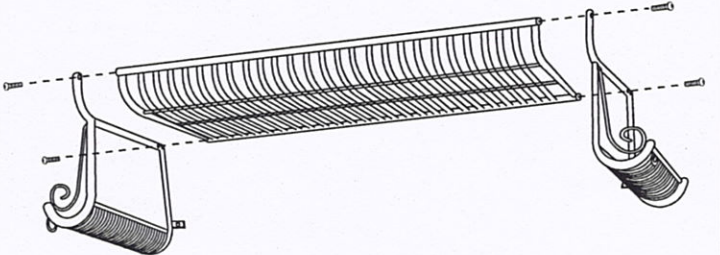
1

AX4

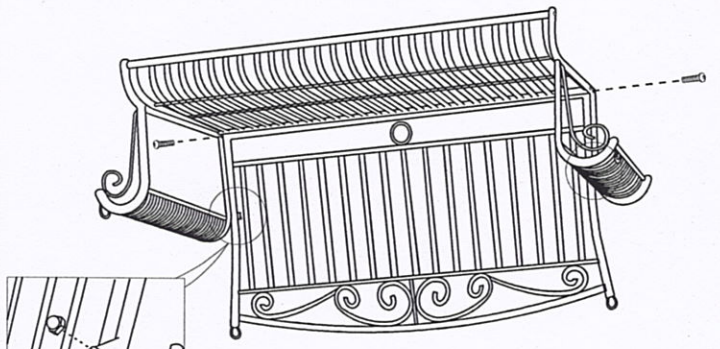

3

AX2



BX2



2

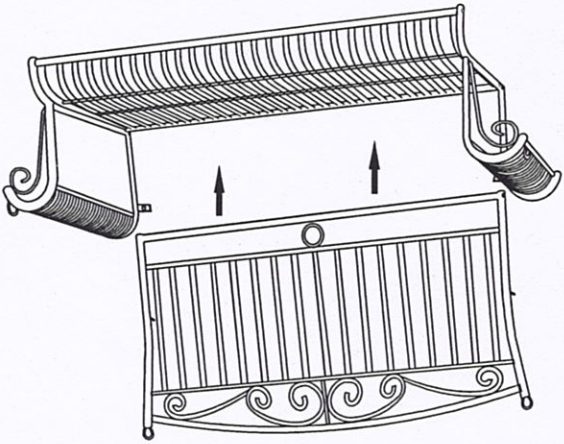

4

Please use pliers to fully tighten hook screw "C".

CX4 DX4

